

ADI SOYADI:

6.HAFTA

TÜRKÇE

1.SINIF TEMEL DERSLER ÇALIŞMA KAĞIDI

Varlıkların adlarını söyleyelim. Adında "i" sesi olan varlıkları boyayalım.



Kedi

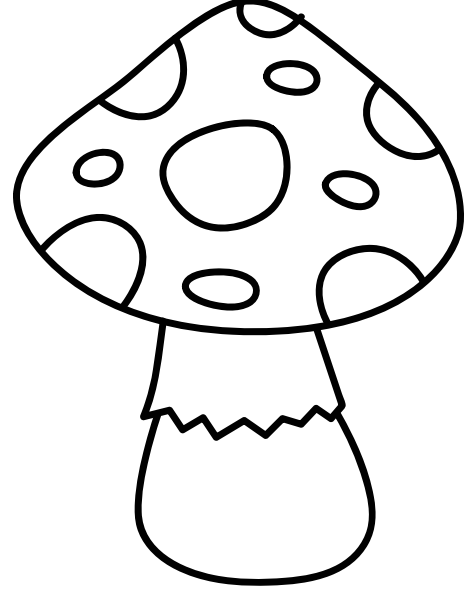

Mantar



Köpek

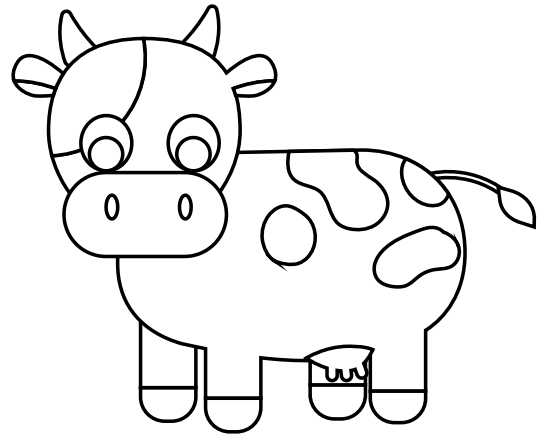

İnek

ADI SOYADI:

6.HAFTA

TÜRKÇE

1.SINIF TEMEL DERSLER ÇALIŞMA KAĞIDI



"i" ve "İ" harflerini ok yönünde numaralara göre boyayalım.
Varlıkların adındaki e seslerini yuvarlak içine alalım.

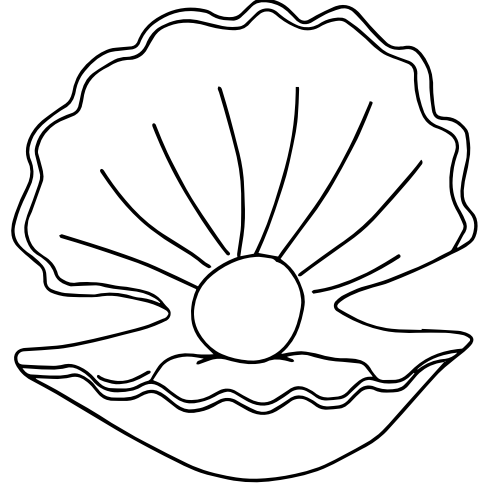
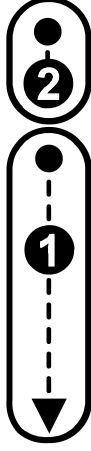

İnci

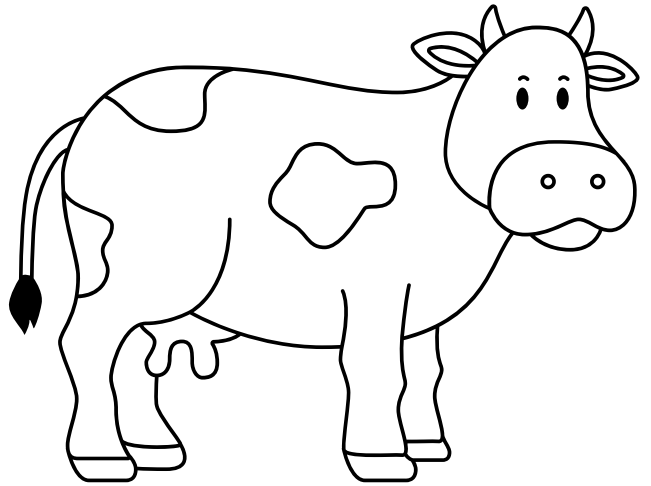
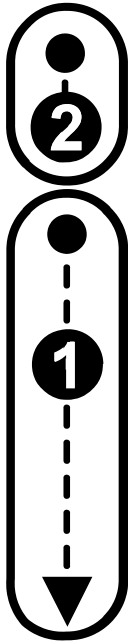

İnek

ADI SOYADI:

6.HAFTA

TÜRKÇE

1.SINIF TEMEL DERSLER ÇALIŞMA KAĞIDI

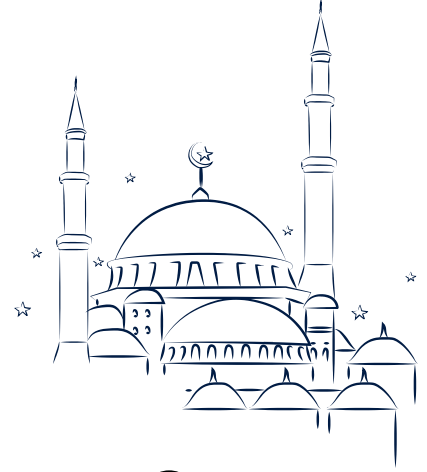
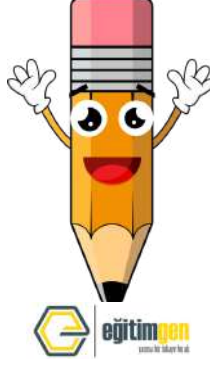
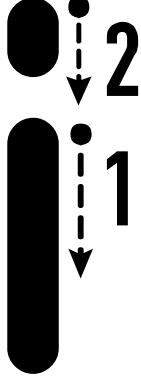

Cami



“i” harflerindeki noktaları birleştirelim ve yazalım.

Handwriting practice line with a dashed line for the letter 'i' and a solid line for the baseline.

Handwriting practice line with a dashed line for the letter 'i' and a solid line for the baseline.

Handwriting practice line with a dashed line for the letter 'i' and a solid line for the baseline.

Handwriting practice line with a dashed line for the letter 'i' and a solid line for the baseline.

Handwriting practice line with a dashed line for the letter 'i' and a solid line for the baseline.

Handwriting practice line with a dashed line for the letter 'i' and a solid line for the baseline.

Handwriting practice line with a dashed line for the letter 'i' and a solid line for the baseline.

Handwriting practice line with a dashed line for the letter 'i' and a solid line for the baseline.

ADI SOYADI:

6.HAFTA

TÜRKÇE

1.SINIF TEMEL DERSLER ÇALIŞMA KAĞIDI

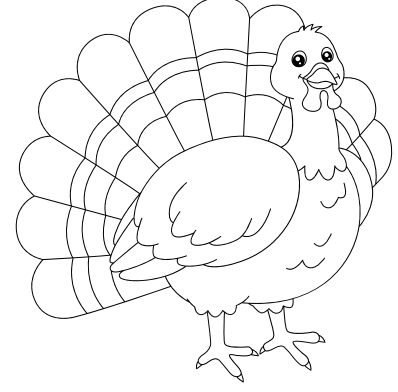
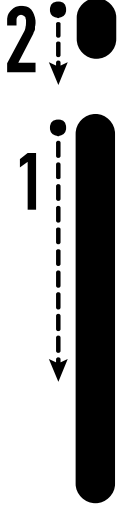

Hindi



“İ” harflerindeki noktaları birleştirelim ve yazalım.

Handwriting practice lines consisting of eight horizontal rows. Each row has a yellow background and a dashed blue line in the middle. The first row has vertical dashed lines dividing it into ten columns. The remaining seven rows are blank for writing.

ADI SOYADI:

6.HAFTA

TÜRKÇE

1.SINIF TEMEL DERSLER ÇALIŞMA KAĞIDI



Haydi öğrendiğimiz harfleri tekrar edelim.
Verilen hece ve kelimeleri okuyup yazalım.

en

an

na

ne

at

et

ta

te

tan

ten

tane

anne



Aşağıdaki hece ve kelimeleri okuyup yazalım.

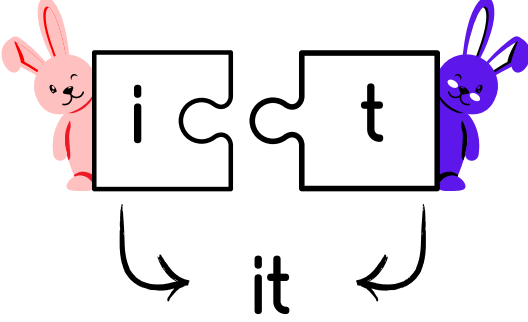

it

it

it

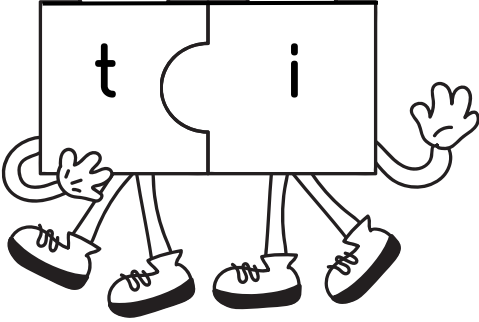

ti

ti

ti

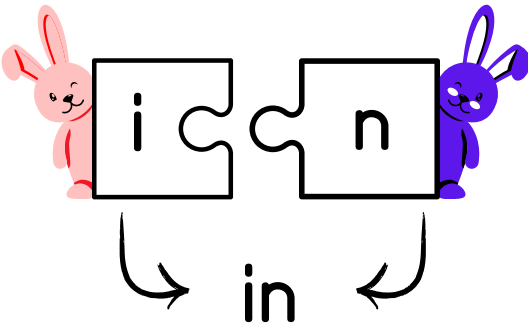

in

in

in

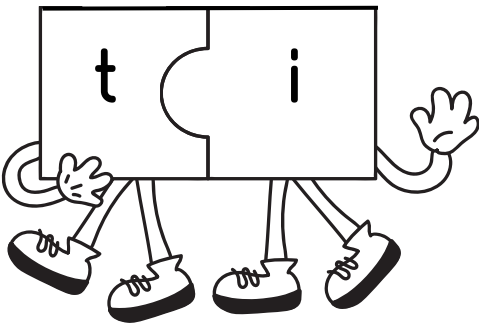

ti

ti

ti

ADI SOYADI:

6.HAFTA

TÜRKÇE

1.SINIF TEMEL DERSLER ÇALIŞMA KAĞIDI



Aşağıdaki hece ve kelimeleri okuyup yazalım.

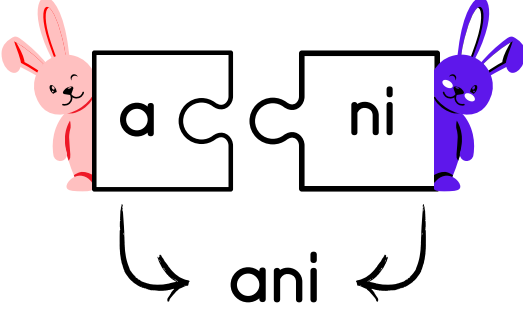

ani

ani

ani

ani

ani

ani

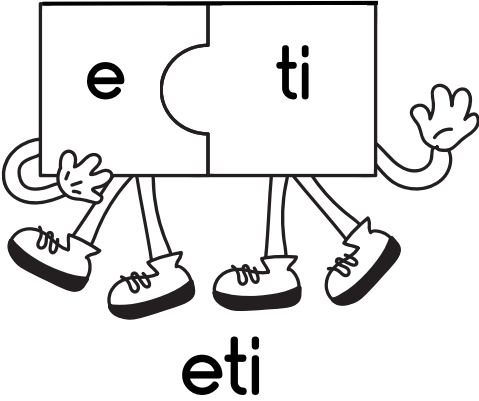

eti

eti

eti

eti

eti

eti

ADI SOYADI:

6.HAFTA

TÜRKÇE

1.SINIF TEMEL DERSLER ÇALIŞMA KAĞIDI



Aşağıdaki hece ve kelimeleri okuyup yazalım.

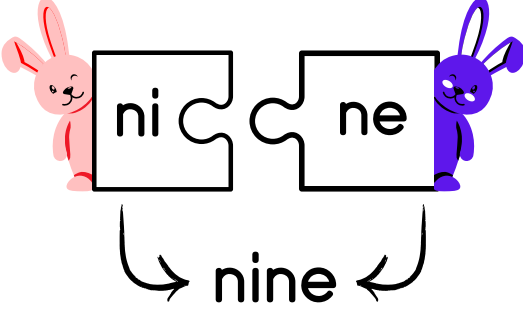

nine

nine

nine

nine

nine

nine

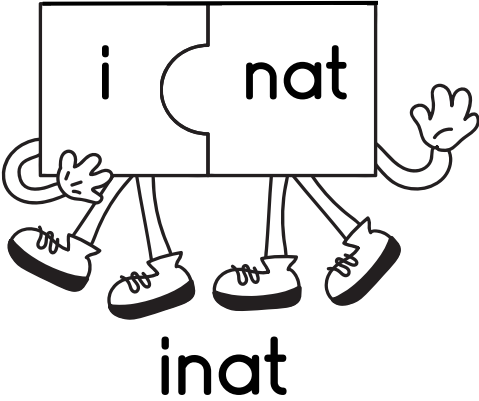

inat

inat

inat

inat

inat

inat

ADI SOYADI:

6.HAFTA

MATEMATİK

1.SINIF TEMEL DERSLER ÇALIŞMA KAĞIDI

4



"4" Rakamındaki noktaları birleştirelim ve yazalım.

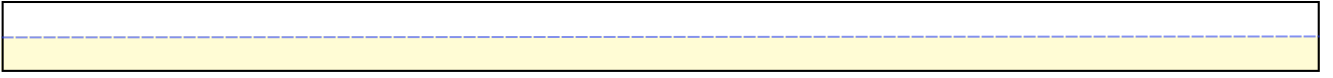
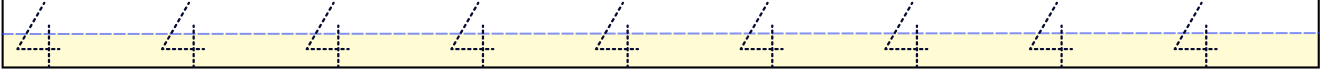

5



"5" Rakamındaki noktaları birleştirelim ve yazalım.

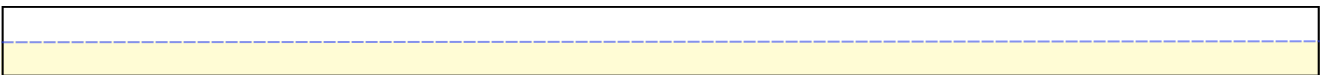
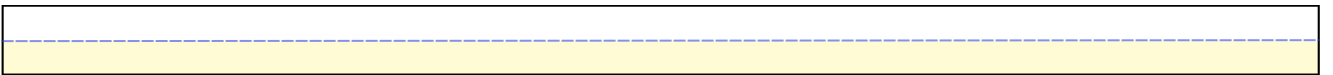
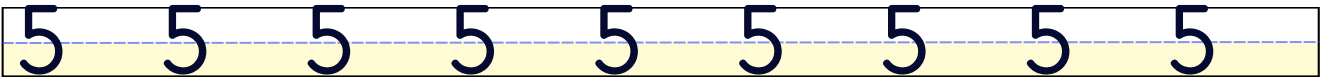
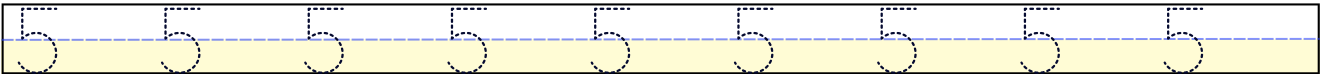

ADI SOYADI:

6.HAFTA

MATEMATİK

1.SINIF TEMEL DERSLER ÇALIŞMA KAĞIDI

6



"6" Rakamındaki noktaları birleştirelim ve yazalım.

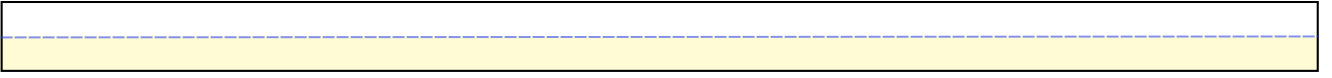
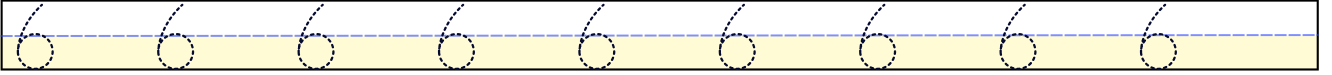

7



"7" Rakamındaki noktaları birleştirelim ve yazalım.

